



TRAMPOLINE MANUAL

**ASSEMBLY, INSTALLATION, CARE,
MAINTENANCE, AND USE INSTRUCTIONS.**

6FT, 8FT, 10FT, 12FT, 14FT & 16FT

 **WARNING!**

Read these materials prior to assembling and using this trampoline and trampoline enclosure. Keep this manual so you can refer to it later.
Not recommended for children under six years of age.

TABLE OF CONTENTS

	Page
1. Disclaimer & Liability	3
1a. Initial Safety Warning	3
1b. Trampoline Safety and Accident Prevention	4
1c. Owner's & Supervisor's role in Preventing Injuries & Responsibilities	5
1d. Owner's role in Preventing Injuries & Responsibilities	5
1e. Weight Limit	5
2. Caring For Your Trampoline	6
3. Installation	7
3a. Pre-Installation Check	7
3b. Inspection checklist	7
3c. Location & Area Placement	8
3d. Parts Checklist	9-10
3e. Assembling the frame	11-13
3f. Assembling the Jumping Mat	14-16
3g. Assembling the Ladder	16
3h. Assembling the Storage Compartment	16
3i. Assembling the Safety Pads	17
3j. Assembling the Safety Net	18-23
3k. Assembling the Anchor Kit <i>(If available)</i>	23
3l. Assembling the Basketball Kit <i>(If available)</i>	24-25
4. Troubleshooting Guide	27-28
5. Warranty	29
5a. Initial Safety Warning	29

1. DISCLAIMER

Whilst we endeavour to ensure that this product offers the highest level of protection, given the nature of this product, some risk still exists. The user of this product assumes all risk associated with injury if they misuse this product.

WARNING!

In addition to the instructions and precautions provided with your trampoline, the following precautions must be observed while using the Trampoline Safety Enclosure.

1a. Initial Safety Warning

1. Do not attempt or allow somersaults on the trampoline. Landing on the head or neck can cause serious injury, paralysis or death, even when landing on the center of the mat.
2. Do not allow more than one person on the trampoline or inside the trampoline enclosure. Being used by more than one person at the same time can result in serious injuries.
3. Keep objects away which could interfere with performer. Maintain a clear area around the trampoline. Do not allow foreign objects or animals on the trampoline.
4. Use the trampoline and trampoline enclosure with mature, knowledgeable supervision.
5. Trampolines over 20 inches (50cm) tall are not recommended for children under 6 years of age.
6. The trampoline should be completely assembled before each use. All springs must be attached to the frame.
7. The frame cover must be positioned correctly at all times.
8. Never set-up the trampoline in heavy rain, wind or storm conditions, especially lightning storm. It is recommended that the trampoline be taken apart and stocked in bad weather.
9. When moving the assembled trampoline and trampoline enclosure, have at least four people evenly spaced around the frame (NSEW) to lift the trampoline off the ground.
10. Inspect the trampoline & enclosure before each use. Ensure the frame cover, barrier mesh, and enclosure support padding are correctly and securely positioned.
11. The metal frame of the trampoline and trampoline enclosure will conduct electricity. Lights, extension cords, and all such electrical equipment must never be allowed to come in contact with the trampoline or trampoline enclosure.
12. Wear comfortable clothing. Remove all jewellery, necklaces and earrings. Wear clothing free of drawstrings, hooks, loops or anything that could get caught in the barrier mesh.
13. Enter and exit the enclosure only at the enclosure door or barrier opening designated for that purpose. It is dangerous practice to jump from the trampoline to the ground or floor when dismounting, or jump to the trampoline when mounting.
14. Do not use the trampoline as a springboard to other objects.
15. We recommend you flex your knees when bouncing on the mat to gain control over movement. Once you gain confidence with this movement, you can proceed with endeavoring more.
16. Familiarize yourself with essential jumping positions and bounces before attempting more progressed techniques. There are a series of combinations that can be performed with or without extra bounces between the feet and the mat.
17. Work on low and controlled movements instead of height when bouncing. Work on your form and technique so you can constantly land on the centre of the trampoline.
18. Control bounce by keeping your head straight and eye level directly in front of you.
19. Avoid bouncing when tired. Keep turns short.

20. Properly secure the trampoline when not in use. Protect it against unauthorized use. If a trampoline ladder is used, the supervisor should remove it from the trampoline when leaving the area to prevent unsupervised access by children.
21. Do not consume drugs or alcohol when using the trampoline.
22. For additional information concerning the trampoline equipment, contact the seller.
23. For information concerning skill training, contact a certified trampoline instructor.
24. Bounce only when the surface of the Mat is dry. Wind or air movement should be calm to gentle. The trampoline must not be used in gusty or severe winds. The trampoline should be taken apart or stored indoors during these types of weather conditions.
25. Read all instructions before using trampoline and trampoline enclosure. Warnings and instructions for care, maintenance, and use of this trampoline and trampoline enclosure are introduced to promote safe, enjoyable use of this equipment.
26. Do not intentionally bounce off the barrier.
27. Do not attempt to jump over the barrier, or crawl under the barrier.
28. Do not hang from, kick, cut or climb on barrier
29. Do not attach anything that is not a manufacturer approved accessory or part of the enclosure system.
30. Children may be entangled or strangled in loose cords or gaps between trampoline and enclosure. Keep the enclosure tightly fastened to the trampoline in accordance with the manufacturer's instructions. Failure to properly assemble and maintain a tight, secure trampoline enclosure boundary may result in serious injury, strangulation or death.

**FOR RECREATIONAL USE ONLY.
NOT FOR PROFESSIONAL USE.**

Failure to follow all instructions and warnings exactly may result in serious injury and/or damage to the product which will void all implied and express warranties

1b. Trampoline Safety and Accident Prevention

As in most recreational sports, participants may be injured. This section covers most of the accidents. Accident prevention responsibilities for jumper and supervisor are outlined.

The following are reasons why accidents happen:

1. **ATTEMPTING SOMERSAULTS.** Landing on the head or neck can cause serious injury, paralysis, or death, even when landing on the centre of the bed.
2. **MORE THAN ONE PERSON ON THE TRAMPOLINE.** Use by more than one person at the same time can result in serious injuries.
3. **INCORRECT MOUNTING AND DISMOUNTING.** Carefully crawl out and into the trampoline. Do not jump off to the ground. Do not jump from a roof, or other objects onto the trampoline. Small children may need assistance to get on or off the trampoline. Do not step onto the suspension system.
4. **HITTING THE FRAME.** Keep on the centre of the trampoline when jumping. Injury may result from hitting the frame when control is lost. Be sure the frame cover is always on and the pad securely fastened. Do not jump directly to the pad.
5. **LOSS OF CONTROL.** A jumper who loses control will increase his/her chance of injury. Be sure to familiarize yourself with basic jumps before doing more difficult ones. Jumps should be mastered, performed repeatedly before moving to next level. To regain control and stop your jump, bend your knees sharply as you land.
6. **ALCOHOL AND DRUG USE.** Because alcohol and drug use impairs the jumper's coordination, loss of control as well as injuries are greatly increased.
7. **FOREIGN OBJECTS.** Please make sure there is nothing sharp under or around the trampoline. Hitting the objects under the trampoline can cause injury. Jumping with a foreign object can also increase chance of getting injured. Be sure there is adequate clearance 8 meters above and 2 meters around the trampoline. Be sure of overhead wires, tree limbs, etc.

8. **BAD WEATHER.** Do not use your trampoline in inclement weather conditions. Please ensure the trampoline is dry and clean before each use. Check for punctures on the bed, sharp burrs on the frame, stitching that has gone bad or loose elastic bands. If a replacement part is needed, please contact supplier to order.

9. **LIMITED ACCESS.** The trampoline should be covered or dis-assembled when not in use. This will prevent unsupervised small children from using the trampoline.

1c. Owner’s & Supervisor’s role in Preventing Injuries & Responsibilities

The supervisor’s role is to make sure the users know all the safety rules as well as learn the basic, fundamental bounces. They need to enforce all the safety rules in the manual, frame and labels.

When a supervisor is not available, the trampoline should be dis-assembled or covered to limit access. It is the supervisor’s responsibility that a placard with the Trampoline Safety Tips is placed where all jumpers are informed about the tips.

1d. Users role in Preventing Injuries & Responsibilities

The jumpers should learn all of the basic, fundamental bounces before attempting more difficult ones. Low controlled bounces are a good start before learning basic landing positions and combinations.

Jumpers need to understand that control is key to successful jump. Contact a certified trampoline instructor for more information.

1e. Weight Limit

Do not exceed the weight limit for the trampoline

6ft ----- 80kg	8ft ----- 80kg	10ft ----- 100kg	12ft ----- 125kg	14ft ----- 150kg	16ft ----- 150kg
-----------------------------	-----------------------------	-------------------------------	-------------------------------	-------------------------------	-------------------------------

2. CARING FOR YOUR TRAMPOLINE

1. Assemble your trampoline with accessories and parts that are provided and recommended by the seller. Parts not supplied in the packaging should not be used
 2. Inspect all areas of trampoline prior to each use
 3. Use soft scrubs or material to clean trampoline mat
 4. We recommend 4 adults to move the trampoline
-

3. INSTALLATION

3a. Pre-Installation Checks



WARNING!

Inspect the trampoline and enclosure before using and replace all worn, defective and missing parts.
The following conditions could represent potential hazards:

1. Missing, incorrectly positioned or insecurely attached frame padding, barrier or enclosure support system (frame) padding and pole caps.
2. Holes, frays or tears worn in the bed or frame padding, barrier or enclosure system (frame) padding and pole caps.
3. Deterioration in the stitching or fabric of the bed and frame padding, barrier or enclosure support system (frame) padding and pole caps.
4. Ruptured springs or bands
5. A bent or broken frame or supporting system
6. A sagging barrier or bed.
7. Sharp protrusions on the frame or suspension system
8. Loosened or missing hardware.

3b. Checklist

Location of the Trampoline	
Trampoline is positioned on shock absorbent, level surface e.g. lawn or bark (do not set up on concrete and other hard surfaces)	
Trampoline is positioned at least 2 metres away from walls, trees and other objects	
The area underneath the trampoline is clear	
Overhead clearance needs to be at least 8 metres from the ground	
Condition of the trampoline	
Frame padding is securely positioned	
Replace any worn, defective or missing parts	
Inspect trampoline bed	
Check the trampoline bed and frame padding for holes, tears, fraying, cracks or deterioration due to UV exposure.	
Check the springs are securely attached	
Check metal parts (frame, poles, bolts, legs) for rusting and breakage	
Check the safety-net for holes, tears and stretching	

3c. Location & Area Placement







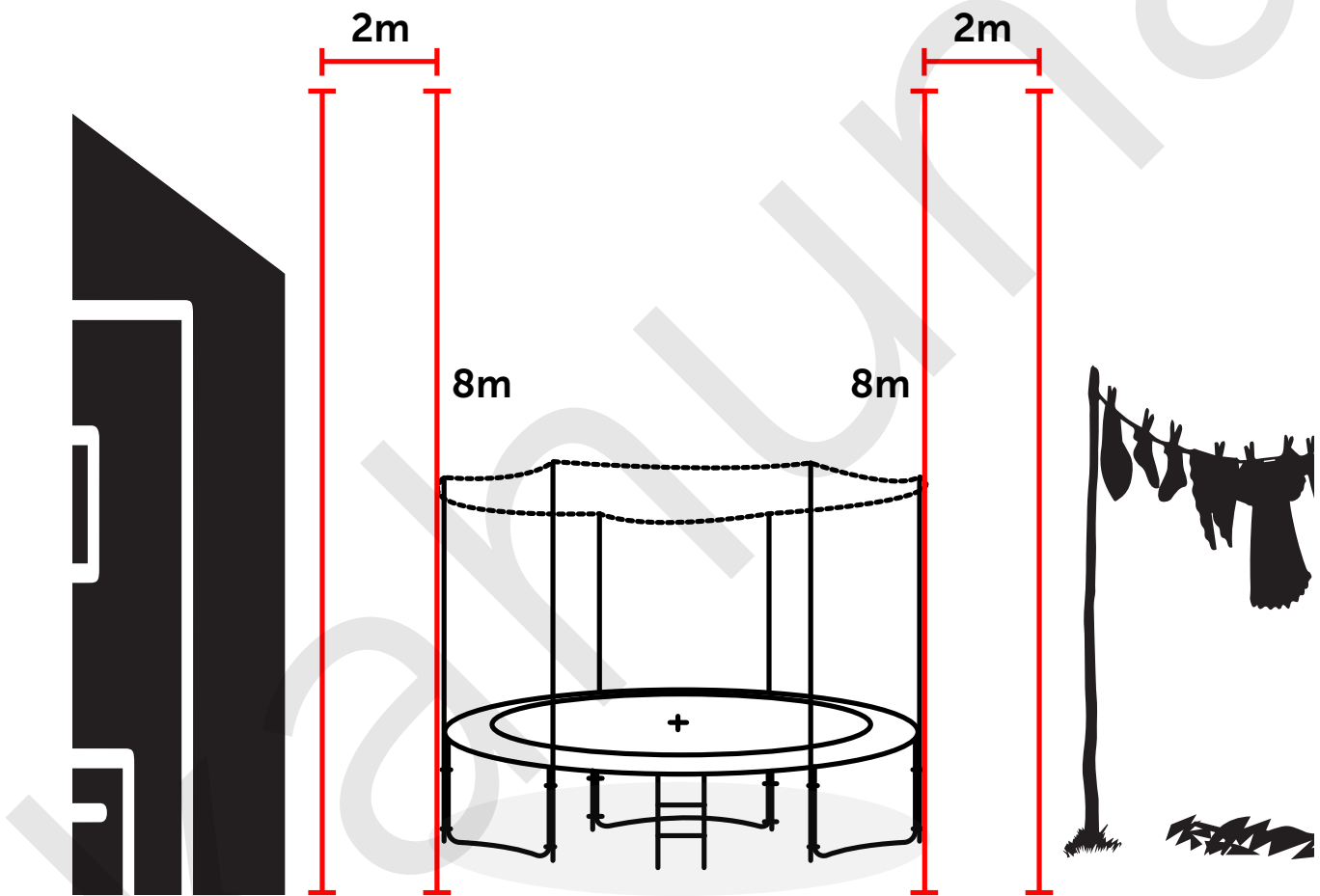

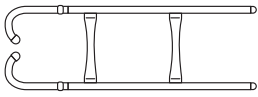
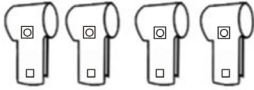

1. Allow sufficient space around the Trampoline
2. Select a shock-absorbent, level surface such as lawn or bark (do not set-up on concrete and other hard surfaces)
3. Keep your trampoline stable during the set up process by using heavy objects such as weights or sandbags
4. Ensure area is clutter free and away from overhead hazards

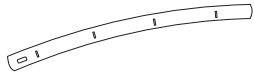
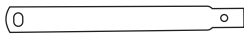





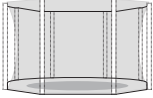

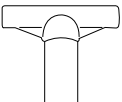
Recommended Installation

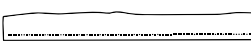
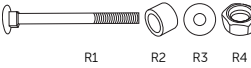
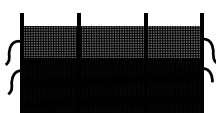

3d. Parts Checklist

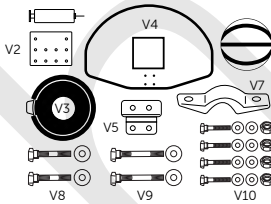
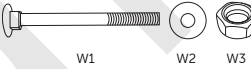
Part No.	Description	Image	Quantity per Model					
			6ft	8ft	10ft	12ft	14ft	16ft
A	Ladder		1	1	1	1	1	1
B	Rail Connector		6	6	8	12	12	12
C	M6 Screw Set		0	0	8	12	12	12
D	Top Rail		6	6	8	12	12	12
E	Leg Extension		0	0	8	12	12	12
F	U Shape Legs		3	3	4	6	6	6
G	Springs		36 135mm	48 135mm	64 135mm	72 165mm	96 165mm	108 178mm
H	Safety Pad		1	1	1	1	1	1
I	Jumping Mat		1	1	1	1	1	1
J	Spring Tool		1	1	1	1	1	1
K	Safety Net		1	1	1	1	1	1
L	Net Rope Set		1	1	1	1	1	1
M	T Section		6	6	8	12	12	12

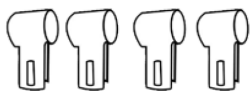
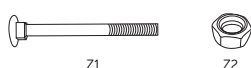
N	Lower Net Pole	 Pole & Foam included	6	6	8	12	12	12
O	Upper Net Pole Type A		5	5	7	11	11	11
P	Upper Net Pole Type B		1	1	1	1	1	1
Q	Pole Sleeves		6	6	8	12	12	12
R	Bolts, Nuts & Washers (M6x78mm)	 R1 R2 R3 R4	12	12	16	24	24	24
S	Storage Compartment		1	1	1	1	1	1
T	Fiberglass Rods		6	6	8	12	12	12
U	Anchor Kit (Optional)	 U1 U2	1	1	1	1	1	1
V	Basketball Set (Optional)	 V2 V3 V4 V5 V7 V8 V9 V10	1	1	1	1	1	1
W	Bolts, Nuts & Washers (M6x45mm)	 W1 W2 W3	6	6	8	12	12	12
X	Bar		3	3	4	6	6	6
Y	T Shape Connector		6	6	8	12	12	12
Z	Bolts & Nuts (M8x50mm)	 Z1 Z2	12	12	16	24	24	24

3e. Assembling the frame

! WARNING!

2 adults in good physical condition are required for the following assembly.
Wear proper shoes and maintain balance to prevent a fall.

When installing the trampoline please make sure you have clear access around the trampoline.

Failure to follow all instructions and warnings exactly may result in serious injury and/or damage to the product which will void all implied and express warranties

Step 1

Attach the Top Rail (**Part D**) with a Rail Connector (**Part B**).

Note: Rail Connector (**Part B**) Square hole side should face the outside of the trampoline and round hole side inside of the trampoline.



1 - Square Hole
2 - Round Hole

Step 2

Attach the Top Rail (**Part D**) with Top Rail (**Part D**) and Rail Connector (**Part B**).

Continue this step until you form a round circle with Top Rails (**Part D**).



Step 3

Use the Bolt (**Part Z**) to fasten Top Rails (**Part D**) and rail connector (**Part B**) together.

Continue this step until you form a round circle with Top Rails (**Part D**).

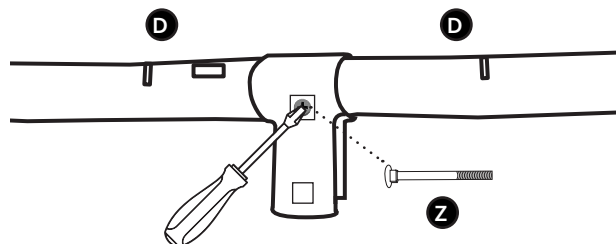

Step 4

For 6ft/8ft trampoline please go to step 5

Begin by attaching Leg Extension (**Parts E**) to the U Shape Leg (**Parts F**) using M6 Screw (**Parts C**) to hold them together

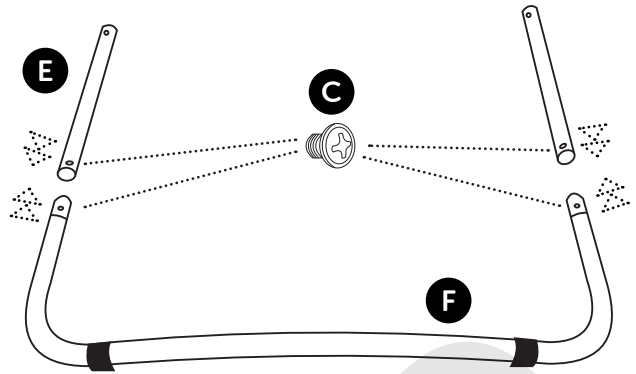

Step 5

Slide the Bar Connector (**Parts Y**) on Leg Extension (**Parts E**).
6ft/8ft trampoline Bar connector (**Parts Y**) will fit on U Shape Legs (**Parts F**)



Step 6

Lay the U Shape Legs (**Parts F**) with Leg Extension (**Parts E**) when required) in the center of the Top Rail (**Parts D**).

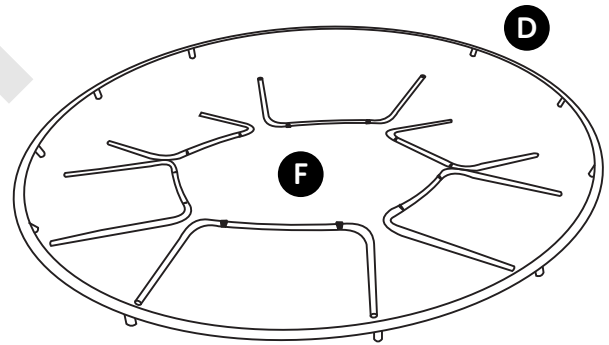

Step 7

Attach the U Shape Leg (**Part F**) with Leg Extension (**Part E** where supplied) to the rail connector (**Part B**) of the trampoline.

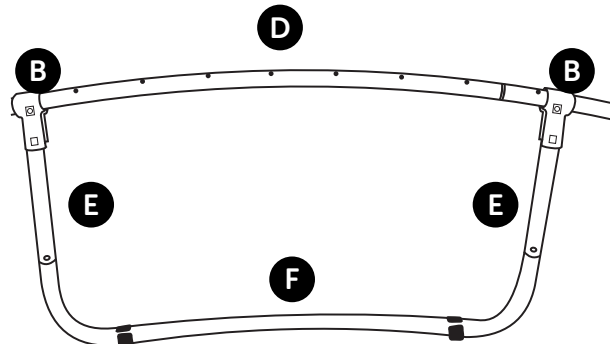

Step 8

Connect the U Shape Leg (**Part F**) with Leg Extension (**Part E** where supplied) to the Rail Connector (**Part B**) of the trampoline with Bolt (**Part Z**)

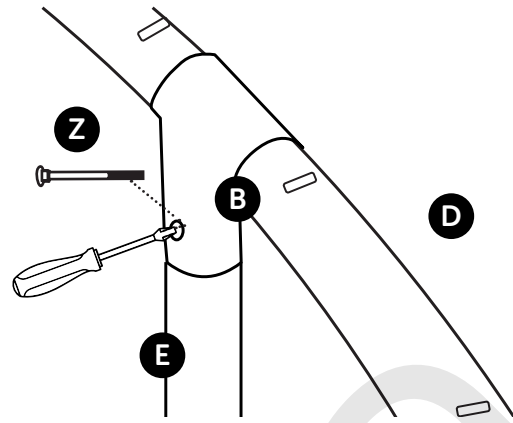

Step 9

Attach the Bar (**Part X**) on T Shape Connectors (**Part Y**) between U Shape Legs (**Part F**) using Bolt (**Part W**)

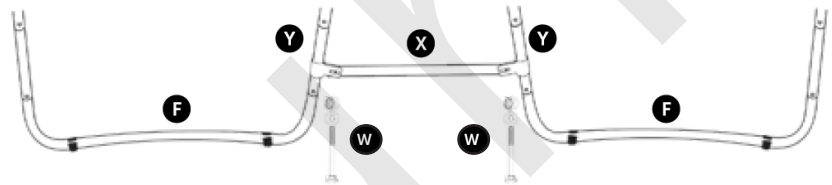

To disassemble. Repeat steps in reverse

3f. Assembling the Jumping Mat

WARNING!

2 adults in good physical condition are required for the following assembly.
Wear proper shoes and maintain balance to prevent a fall.

When installing the trampoline please make sure you have clear access around the trampoline.

Failure to follow all instructions and warnings exactly may result in serious injury and/or damage to the product which will void all implied and express warranties

Step 1

With stitching portion facing down, lay the Jumping Mat (**Part I**) inside frame and attach a Spring (**Part G**) into one of the triangle rings on the mat. Then attach spring with ring to frame. Make sure the mat side of the spring is attached to the triangle ring and the Rail side of the spring is attached to the rail.

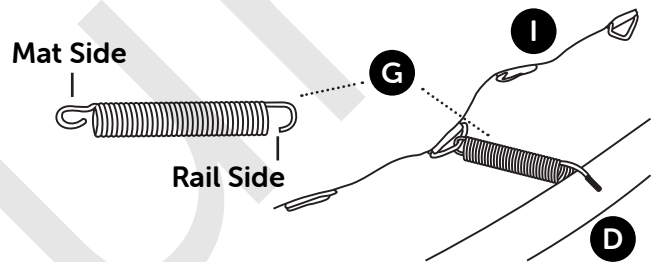

Step 2

Count the loops half away around the mat and attach another spring

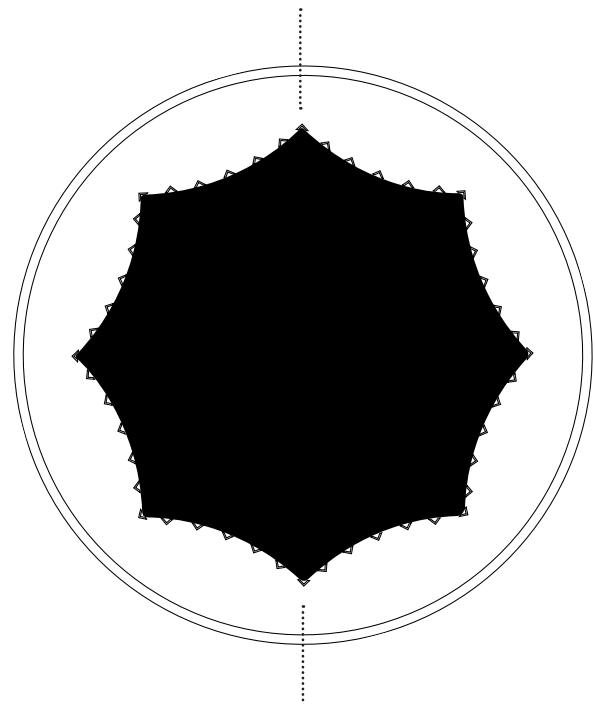

Step 3

Count the notches on the top rim half way around and attach the springs on the mat into the notch.

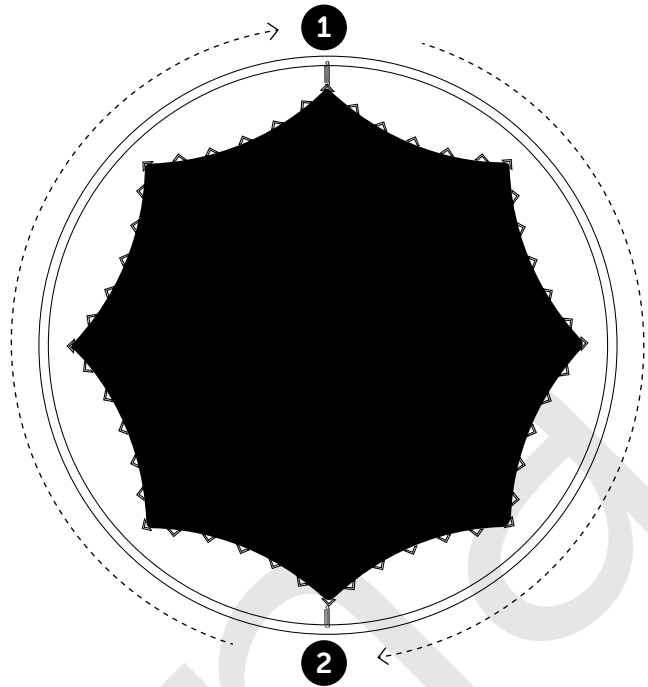

Step 4

Using Spring Hook (**Part J**) start installing the spring. You will need to install the springs on opposite sides of each other one at a time. About $\frac{3}{4}$ of the way around the tension will increase. This is normal you will find it get easier the closer you get to completing the installation of the mat.

WARNING!

Trampoline is under heavy tension. More effort may be required to attach springs to frame. Be careful not to pinch fingers or slip. Please make sure there is clear space behind you when installing the springs as serious injury may occur if care is not exercised.

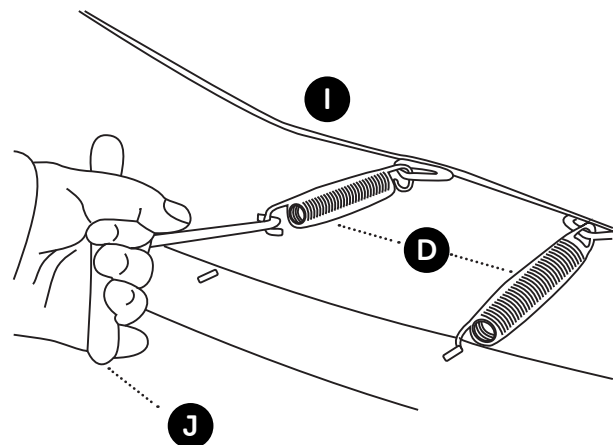
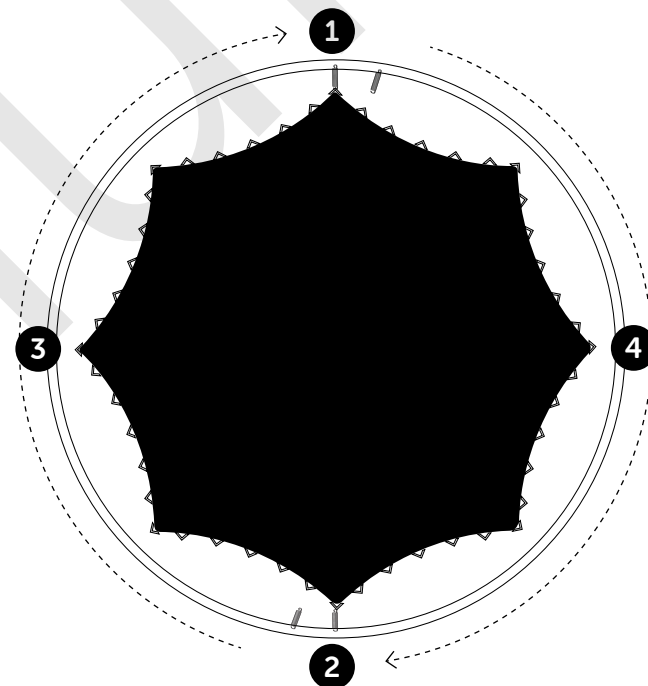

Step 5

Once you have completed the installation of the mat, check that the springs are connected into the rail and mat correctly.

3g. Assembling the Ladder

Step 1

Sit the Ladder (**Part A**) arches onto the Top Rail (**Part D**)

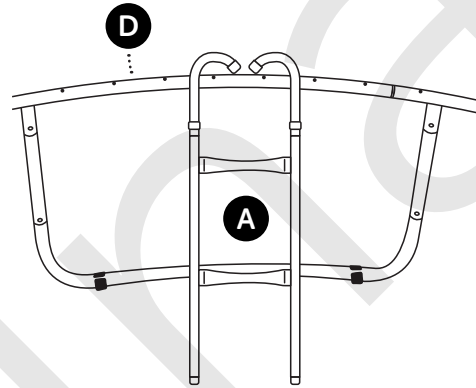

3h. Assembling the Storage Compartment

Step 1

With the opening of the Storage Compartment (**Part S**) facing up, tie the top strap to the Top Rail (**Part D**).

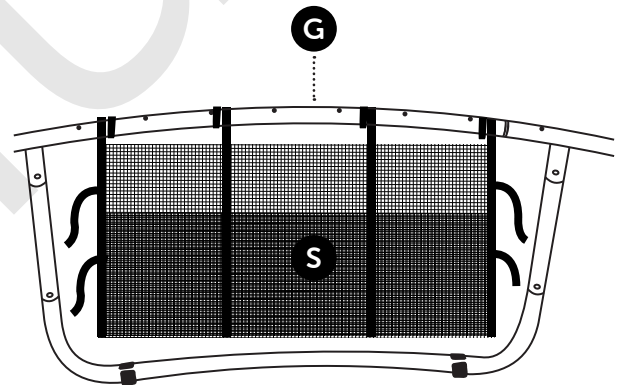

Step 2

Tie the side strap to the Storage Compartment (**Part S**) to each side of the U Shape Legs (**Part F**)

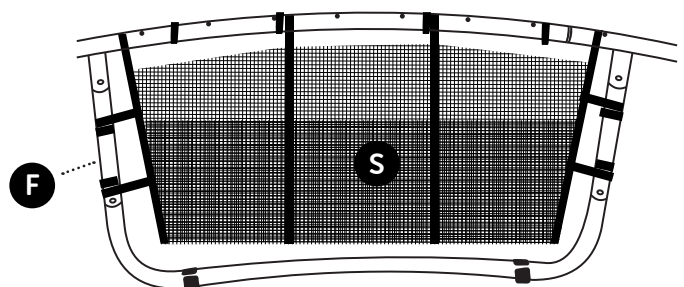

3i. Assembling the Pad

WARNING!

2 adults in good physical condition are required for the following assembly.
Wear proper shoes and maintain balance to prevent a fall.

When installing the trampoline please make sure you have clear access around the trampoline.

Failure to follow all instructions and warnings exactly may result in serious injury and/or damage to the product which will void all implied and express warranties

Step 1

Lay Safety Pad (**Part H**) on outer edge so springs are covered.

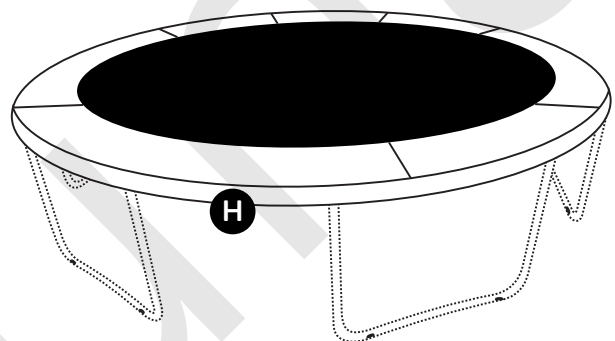

Step 2

Tie the black straps to the Frame.

Do not tie the safety pad black straps to the springs.

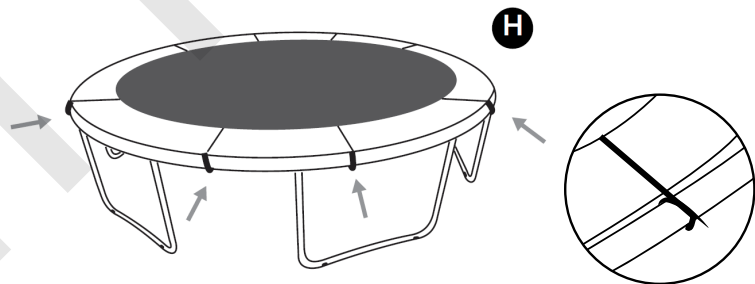

Step 3

Pull the side cover over the edge.

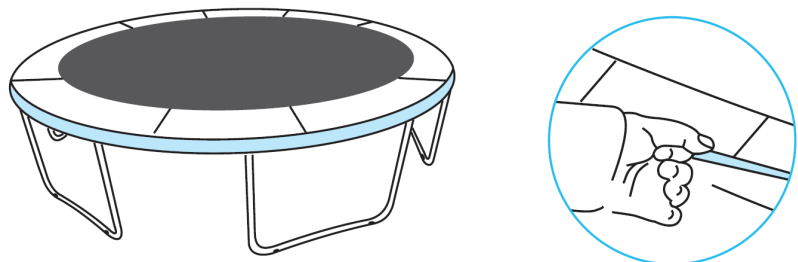

To disassemble. Repeat steps in reverse

3j. Assembling the Safety Net

WARNING!

2 adults in good physical condition are required for the following assembly.
Wear proper shoes and maintain balance to prevent a fall.

When installing the trampoline please make sure you have clear access around the trampoline.

Failure to follow all instructions and warnings exactly may result in serious injury and/or damage to the product which will void all implied and express warranties

Step 1

Install the Lower Net Pole (**Part N**) to the trampoline frame using Bolt (**Part R**). Position the spacer supplied with Bolt (**Part R**) between net pole and trampoline frame.

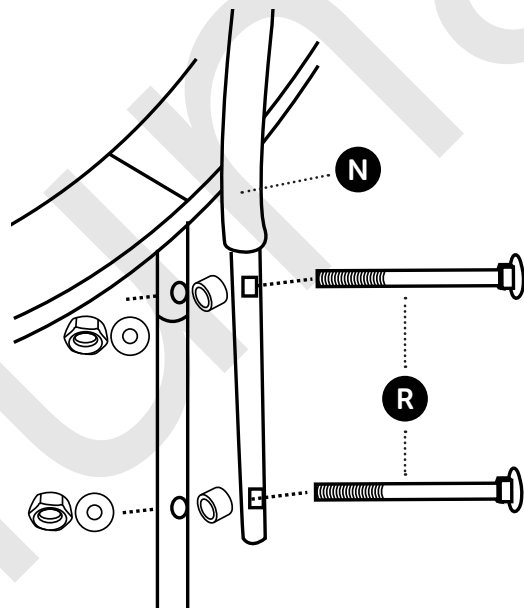

Step 2

Install Upper Net Pole Type B (**Part P**) with basketball attachment where you would like to position the basketball ring on top for the Lower Net Poles (**Part N**)

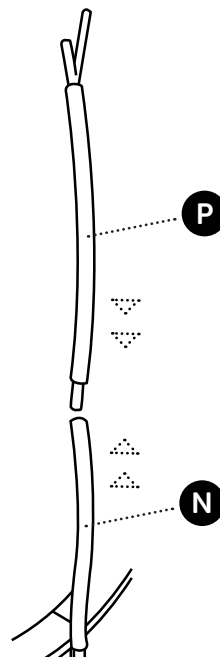

Step 3

Install the rest of the Upper Net Poles Type A (**Part O**) onto the lower net pole (**Part N**)

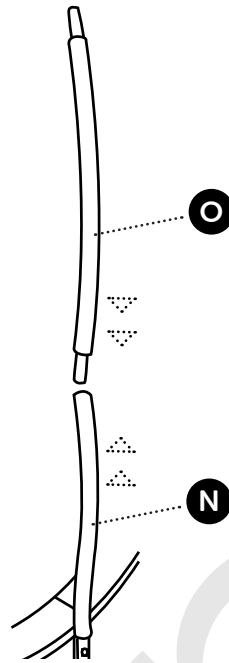

Step 4

Slide the net Pole Sleeve (**Part Q**) onto the net poles

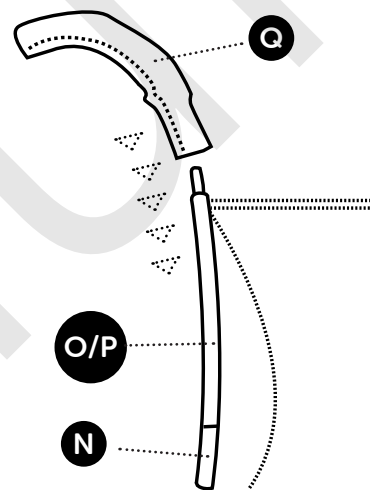

Step 5

Thread the Fibre Glass Rods (**Part T**) through the top of the Net Sleeve of the Safety Net (**Part K**)

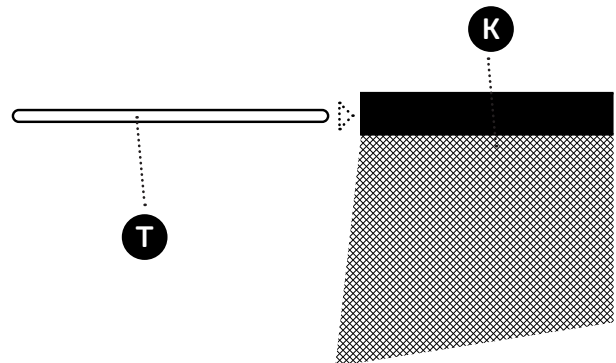

Step 6

Install the T Section (**Part M**) onto the Fibre Glass rods (**Part T**)

PLEASE NOTE: Connecting the last T section will be difficult due to the tension and may require 2 people to connect together

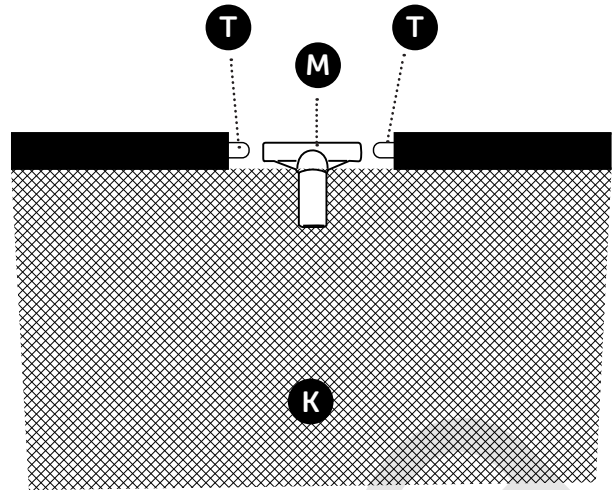

Step 7

Install the T Section (**Part M**) onto the top of the Upper Net Poles (**Part O/P**)

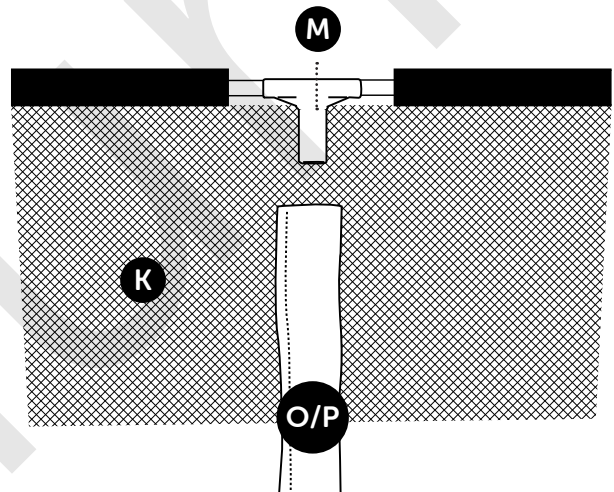

Step 8

Starting at the net entrance, tie the Net Rope Set (**Part L**) to one of the spring loops.

WARNING!

Trampoline is under heavy tension. More effort may be required to attach springs to frame. Be careful not to pinch fingers or slip. Please make sure there is clear space behind you when installing the spring's serious injury may occur!

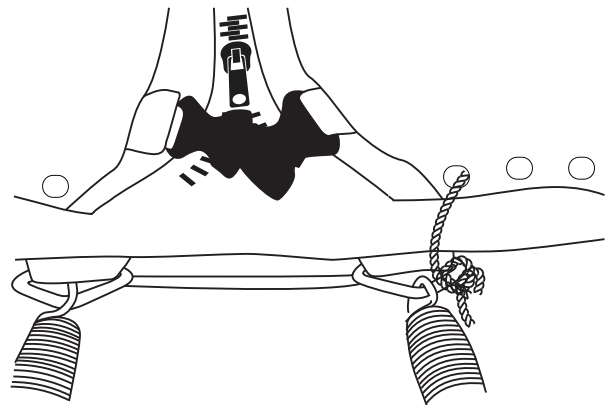

Step 9

To attach the trampoline net to the trampoline, pass the Net Rope Set (**Part L**) through each 4th or 5th net hole (at the bottom of the net) and through every 3rd or 4th spring loop as detailed in the steps below. The net holes through which the rope is passed are to align with the spring loops selected to pass the rope.

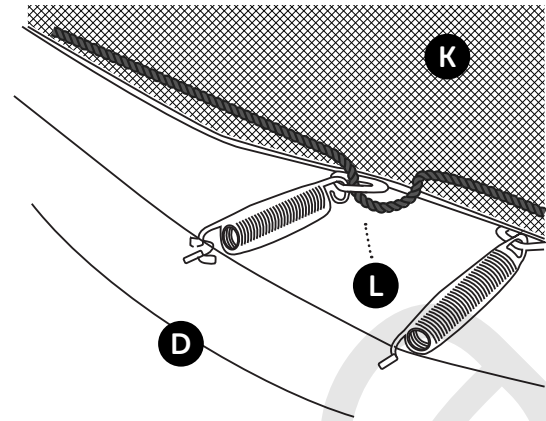

Step 9.1

Feed and intertwine the rope through each 4th or 5th net hole at the bottom of the net and simultaneously feed the rope through each 3rd or 4th spring loop, as shown in step 9.2 below.

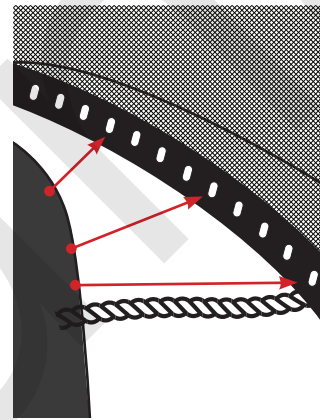

Step 9.2

Feed the rope through the ring and pull back up towards the net and keep feeding through the next 4th or 5th hole in the net.

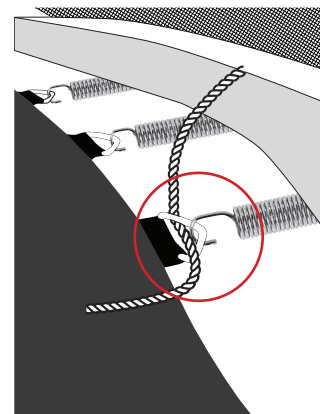
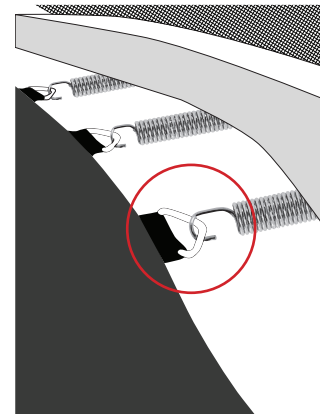

Step 9.3

This is how the net should appear with the rope fed through the spring loop and then continue outside the net and around the net.

Pull the rope tight to ensure the net is wedged tightly under the safety pad. This will ensure the net enclosure is tight around the trampoline.

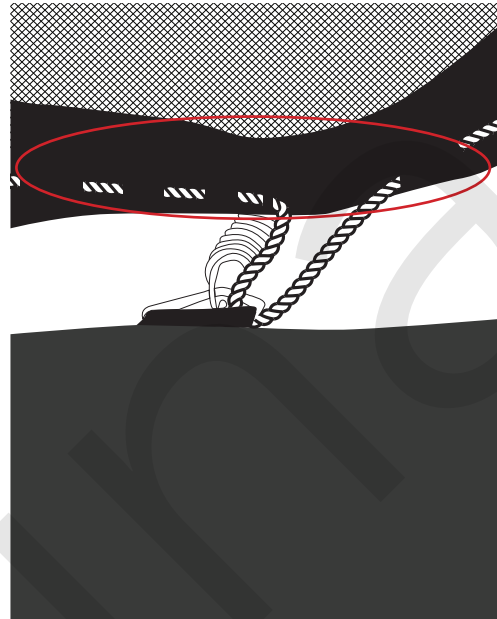
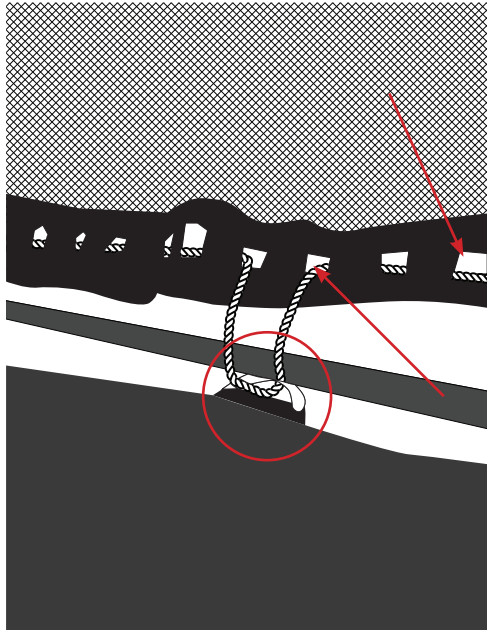

⚠ NOTE!

Select models are supplied with **disposable net-installation-clips** which are an aid to mounting the net. Once the net has been installed, these clips **serve no purpose and can be disposed off**, and are not covered by any warranty

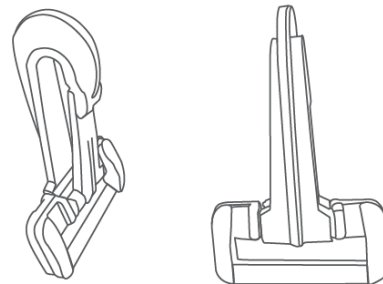

To disassemble. Repeat steps in reverse

3k. Assembling the Anchor Kit (If available)

Step 1

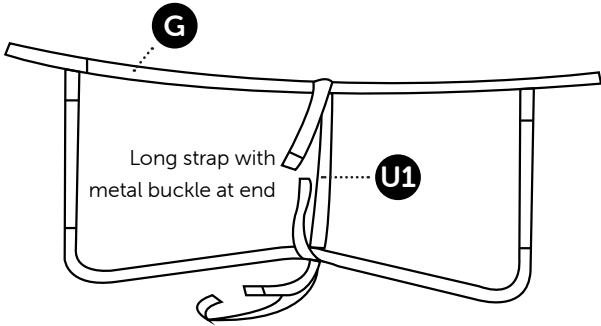

Step 2

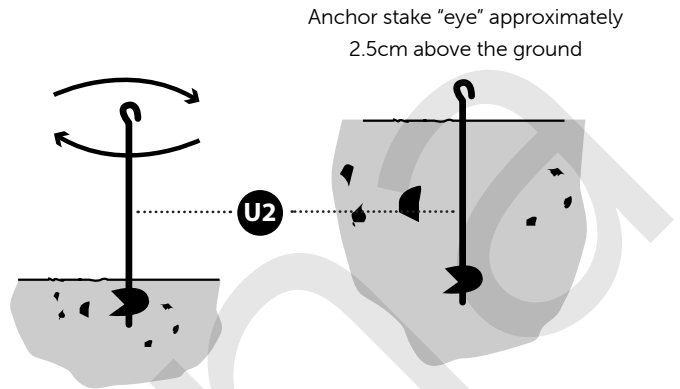

Step 3

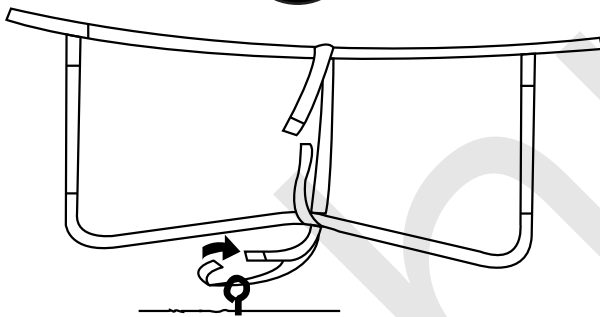

Step 4

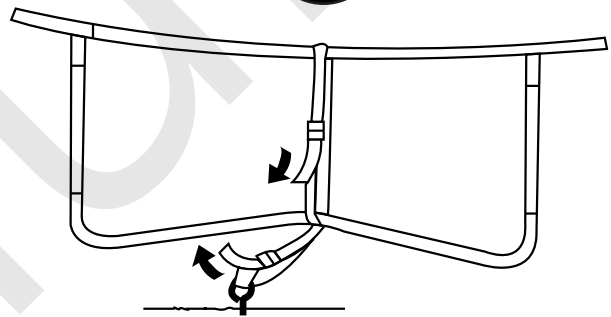

Open end of "eye" should be away from horizontal leg

3. Assembling the Basketball Kit (If available)

Step 1

Install the backplate (**Part V2**) to the back side of the basketball backboard (**Part V4**) with the (**Part V9**) bolts

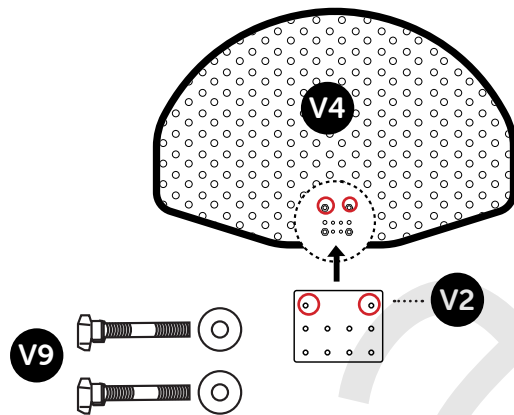

Step 2

Lay the basket ring (**Part V3**) flat on the front backboard (**Part V4**)

Place the bracket (**Part V5**) over the lower part of the ring and screw in the 4 bolts (**Part V10**).

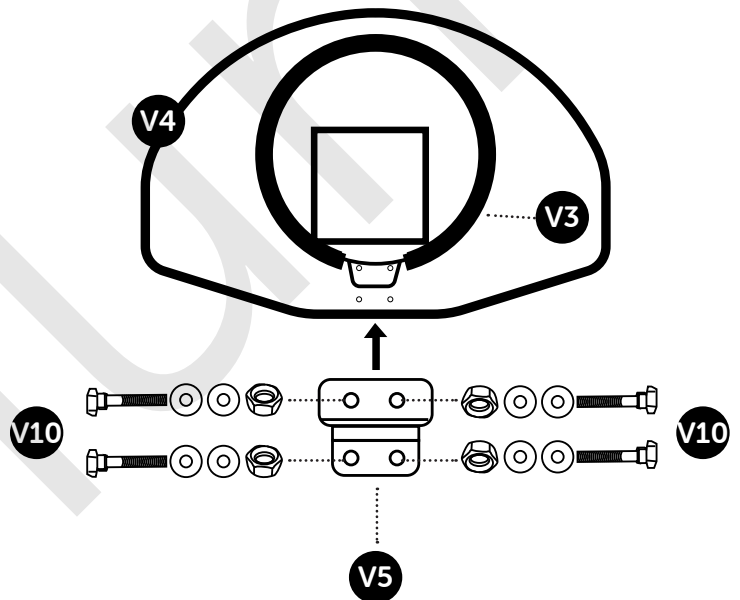

Step 3

Wrap the Net around the ring (**Part V3**)

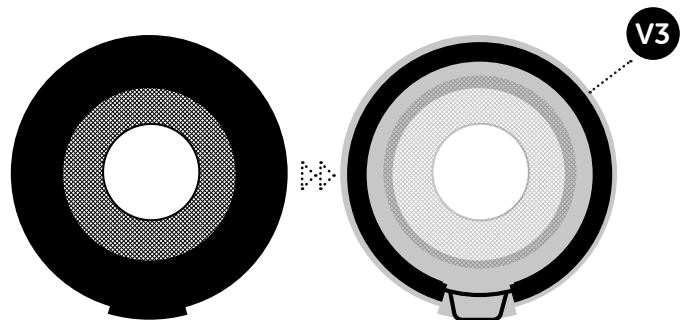

Step 5

Place the bracket (**Part V7**) on the bottom 2 holes of the plate (**Part V4**). Loosely screw the bolts (Part V9) to the bottom 2 holes (**Part V9**)

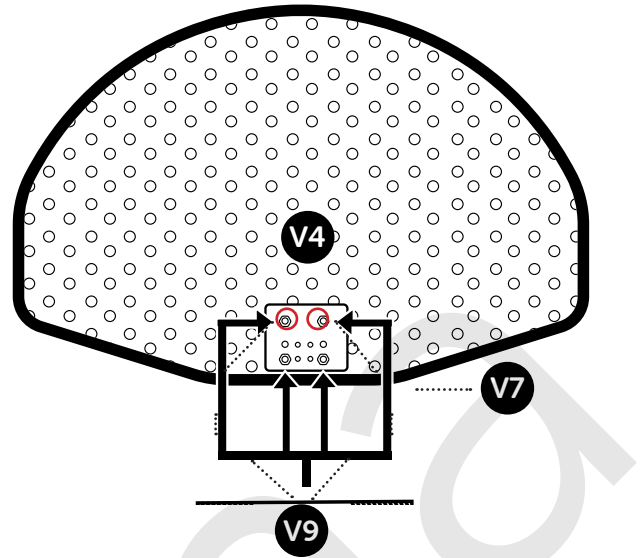

Step 6

Place the completed basketball Set between the bracket and board on the long pole (**Part P**)

Then tighten the bolts to secure the basketball set to the trampoline

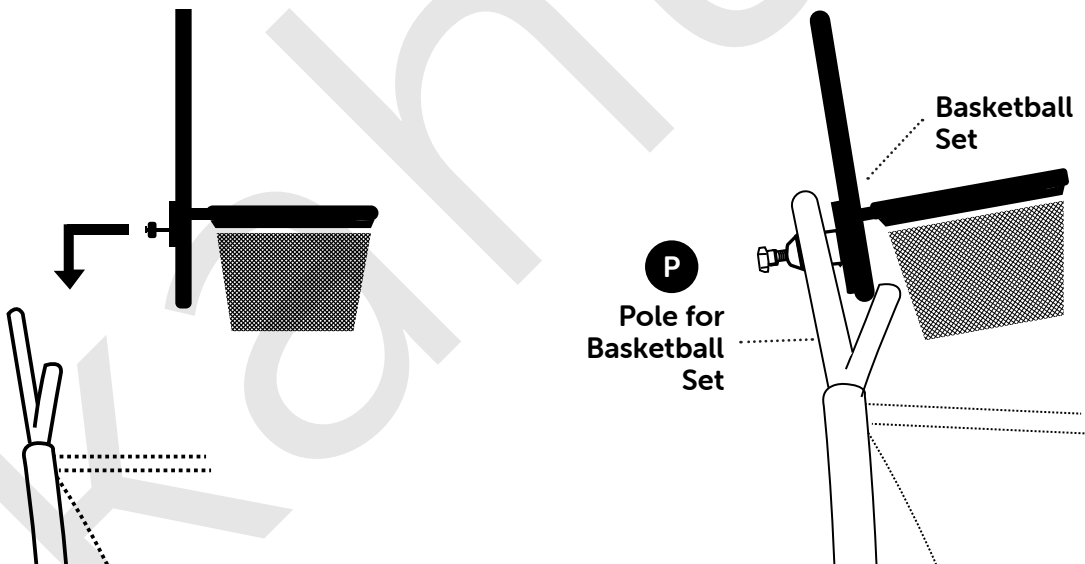

Step 7

using the basketball air pump (**Part V1**) pump up the basketball (**Part V7**)

**YOUR NEW
KAHUNA TRAMPOLINE
IS NOW COMPLETE!**

4. TROUBLESHOOTING

Problem	Probable Cause	Suggested Remedy
Mat not fitting	Spring not installed correctly	Make sure you are doing one spring from opposite side
	Not the right amount of spring loop	Check the mat has the correct amount of spring loops
	Spring is the wrong length	Check the overall length of the spring.
	Mat the wrong size	Measure the overall size of the mat diameter. (do not include the loops)
Trampoline Warping	Leg not square	Make sure the legs are square and not tilting in towards the center of the trampoline and are square to the frame
	Trampoline setup on uneven ground	Trampoline must be installed and used on a flat level surface. Make sure the ground is flat and the trampoline is level
	Trampoline setup on soft ground	Trampoline must be installed and used on a solid flat level surface. A Trampoline should not installed and used on stones, gravel, crushed rock, sand, uneven grass, uneven concrete, soft or loose surfaces.
	Spring is the wrong length	Check the overall length of the spring
	Mat is the wrong size	Measure the overall size of the mat diameter. (do not include the loops)
Net not fitting	Make sure net is on the correct side of the poles	Make sure the net is on the inside of the trampoline between the poles and the jumping for an inner net set up
	Length of the net	Make sure the length on the net when pulled tight is the same height as the net poles from the jumping mat to the top of the pole for an inner net set up
	String around to many springs	Make sure the rope around the bottom of the trampoline is around every 3rd spring and not every spring

Problem	Probable Cause	Suggested Remedy
No bounce	Spring size	Check the overall length of the spring is not too long for the trampoline
	Not the right amount of spring loop	Check the mat has the correct amount of spring loops
	Mat size	Measure the overall size of the mat diameter. (do not include the loops)
Frame issues	Locking nut with nylon	<p>The nuts on this item are locking nuts. They use nylon in the tread of the nut to make it tight so they don't rattle loose, when in use, use a spanner on the nut to do up tight.</p> <p>Make sure you have the correct amount of top rim piece</p>
	Top rim not going together	When connecting the piece of the top rim together it will be very tight. You need to have one person connecting in the last two pieces together and one person on the opposite side apply pressure to stop the frame from moving
	Leg extension for a 6ft and 8 ft trampoline	The 6ft and 8ft trampoline do not include the leg extensions
	T section coming out of poles	When connecting the T sections need to make sure the fiberglass rods are all the way in. To do this lightly press on the fiberglass rods on each side of the T sections (when connected in the net poles) in towards the centre of the trampoline

5. WARRANTY

5a. Initial Safety Warning

- Kmate Pty Ltd provides a 12-month warranty for this product when used for domestic purposes. Commercial use of the product will void all warranty.
- The benefits of this warranty are provided in addition to other rights and remedies you may have under a law in relation to the goods and services to which this warranty relates. Our goods come with guarantees that cannot be excluded under the Australian Consumer Law. You are entitled to a replacement or refund for a major failure and for compensation for any other reasonably foreseeable loss or damage. You are also entitled to have goods repaired or replaced if the goods fail to be of acceptable quality and the failure does not amount to a major failure.
- Before making a claim under warranty, please refer to your user/installation manual to ensure that you have followed correct operating procedures of your product, and refer to the trouble shooting section (if such exists) to assist solving any problems.
- The warranty period begins from the day of purchase.
- Your proof of purchase must be produced before assistance will be provided.
- Where the Product is replaced pursuant to this Warranty, the replacement Product will be subject to the warranty terms and warranty commencement date of the original product.
- This warranty is only valid if the product is operated and maintained in accordance with the manufacturer's instructions.
- Damage to property including but not limited to grass, outdoor areas, outdoor furniture, walls, or any other event either directly or indirectly are excluded from warranty as well as any losses or expenses incurred by you in relation to the product or making a claim under this warranty including without limitation any costs associated with installation, reinstallation or transporting the product.
- A claim may be refused if the defective claim has arisen for reasons other than a manufacturers fault or defective parts or workmanship. Circumstances in which a warranty claim may be declined include, but are not limited to the following:
 1. Normal wear and tear
 2. Misuse or abuse, including failure to properly maintain or service
 3. Damages caused by improper or incorrect installation, force-majeure, abnormal outdoor conditions, inclement weather, lightning etc. are not eligible for warranty repair
 4. Insect or vermin infestation; Failure to clean or improper cleaning and/or operation of the product
 5. If the product is modified without authorization from Supplier in writing;

Contact Details

*Kmate Pty Ltd
PO Box 234, Mount Waverley VIC 3149
Email: warranty@klike.com.au
Phone: 03 9790 0055*





KAHUNA

TRAMPOLINE COVER MANUAL



Product may vary from the image due to constant improvements. Manual is suitable for multiple models

WARNING: Cover is not designed to be a substitute for sun protection or to be used as a shelter from inclement weather, nor will its use prolong the life of the trampoline.

Please read these instructions carefully and retain for future reference

FOR DOMESTIC USE ONLY

Important Warnings

WARNING: DO NOT LEAVE CHILDREN UNATTENDED WHEN USING THIS PRODUCT

CAUTION:

- This product does not offer complete protection against UV and sun exposure. When using this product and the trampoline ensure the users are wearing appropriate attire and sunscreen to sufficiently protect against the sun.
- Do not leave children unattended under the cover as the temperature between the cover and the trampoline may increase very rapidly depending on the outdoor temperature and sun.
- The product is not waterproof.
- Remove the cover when not in use. Avoid leaving it on the trampoline in rain and windy weather to minimize the damage to the cover and the trampoline, through sagging, colour fading and deterioration of material.
- We recommend the use of anchor kits (optional accessory) to minimize the likelihood of strong winds tipping over the trampoline causing damage.

Step 1 - Installation with Basketball Set Pole

- Skip this part if you dont have basketball set
- Positioning yourself outside the trampoline, locate the basketball set pole (marked as Upper Net Pole Type B in the Kahuna trampoline manual) on the trampoline.

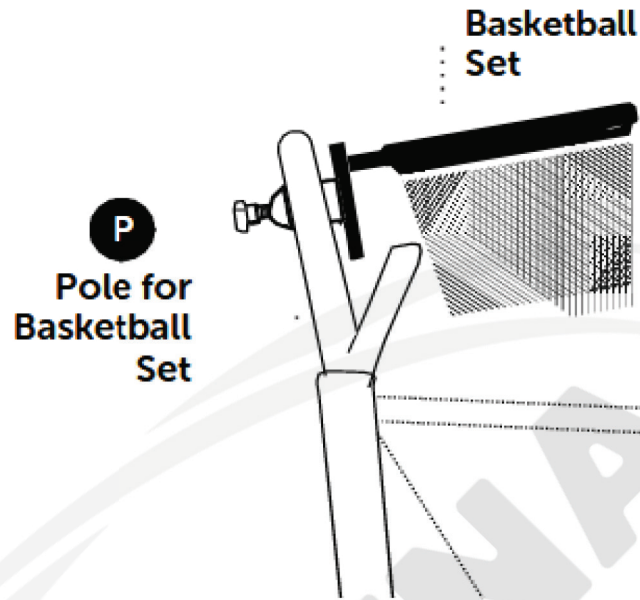

- Place the opening in the cover over Pole Type B and slip the skirt of the cover over the top of the fiber rods on the trampoline.
- Align the vertical orange stitching on the cover with the trampoline poles.
- The basketball set (where supplied) is to sit outside the cover.

Step 2 - Attaching the cover to the trampoline

- Using a ladder, tie the straps located inside the cover, at the top of the cover, around the T-sections connected to the fiber rods



- Work your way down to the second pair of straps on the inside of the cover and securely fasten them around the upper section of the vertical foam pole.



- Repeat the steps for every T-section and pole installed on the trampoline.

Warranty and Contact Details

Kmate Pty Ltd provides a 12 month warranty for this product when used for domestic purposes. This product is not intended for commercial use and any such use will void all warranty.

The benefits of this warranty are provided in addition to other rights and remedies you may have under a law in relation to the goods and services to which this warranty relates. Our goods come with guarantees that cannot be excluded under the Australian Consumer Law. You are entitled to a replacement or refund for a major failure and for compensation for any other reasonably foreseeable loss or damage. You are also entitled to have goods repaired or replaced if the goods fail to be of acceptable quality and the failure does not amount to a major failure.

Before making a claim under warranty, please refer to your user/installation manual to ensure that you have followed correct operating procedures of your product, and refer to the trouble shooting section (if such exists) to assist solving any problems.

The warranty period begins from the day of purchase.
Your proof of purchase must be produced before assistance will be provided.

Where the Product is replaced pursuant to this Warranty, the replacement Product will be subject to the warranty terms and warranty commencement date of the original product.

This warranty is only valid if the product is operated and maintained in accordance with the manufacturer's instructions.

Damage to property including but not limited to trampoline, garden, landscaping or any other event either directly or indirectly are excluded from warranty as well as any losses or expenses incurred by you in relation to the product or making a claim under this warranty including without limitation any costs associated with installation, reinstallation or transporting the product.

Light globes, remote controls, batteries, flywheel belts and chains, filters or similar perishable parts are not covered under this warranty.

A claim may be refused if the defective claim has arisen for reasons other than a manufacturer's fault or defective parts or workmanship. Circumstances in which a warranty claim may be declined include, but are not limited to the following:

- Normal wear and tear;
- Failure by the user to periodically clean the cover by removing the debris and pooled water;
- Colour and material fade;
- Rotting and degradation of material due to water
- Cuts, holes and perforations in the material
- Misuse or abuse, including failure to properly maintain or service;
- Damage caused by improper or incorrect installation, force-majeure, electrical surges, lightning, power grid fluctuations, water or by connection, are not eligible for warranty repair;
- Insect or vermin infestation;
- Failure to clean, or improper cleaning and/or operation of the product;
- If the product is disassembled or modified without authorisation from Kmate Pty Ltd in writing;
- If you are unable to supply a certificate of compliance for installation of any type as required by State & Territory Laws

Contact Details

Kmate Pty Ltd
PO Box 234, Mount Waverley VIC 3149
Email: warranty@klika.com.au
Phone: 03 9790 0055

